

## OPEN SPRING MOUNTS

**OSM-250 open spring mounts** are designed to provide efficient isolation from critical vibrations and efficiently protect structures from transferring vibrations. Top spring cup has a leveling nut for precise adjustments in height. Antivibration rubber cups reduce the transfer of vibrations and noise. Springs are colour coded for an easy identification.

### Recommended for:

HVAC equipment, fan air circulation systems, compressors, pumps, chillers, AC units, cooling towers, inertia bases, etc.

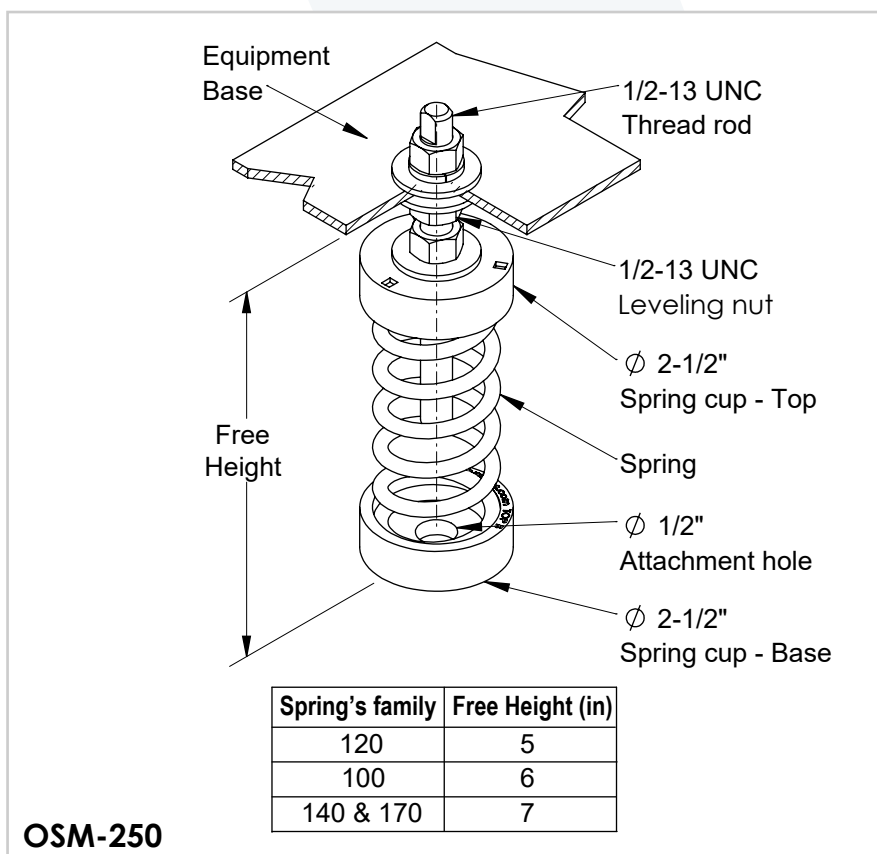

### Features:

- ✓ All springs at rated loads have 50% additional travel to solid load.
- ✓ Leveling nut for easy height adjustment.
- ✓ Safety Factor - Springs will accommodate 50% extra load from rated load to solid load.
- ✓ Spring cup base has an attachment hole for anchoring.
- ✓ Elastomer spring cups provide better vibration isolation, load distribution, and noise reduction.
- ✓ Recommended load range: from 50% of rated load to rated load.
- ✓ Springs are color coded and easily replaceable.
- ✓ Springs have a minimum ratio of 0.8 for the diameter divided by the deflected spring height. (\*)

## 1" DEFLECTION OPEN SPRING MOUNTS

Model	Rated Load (lbs)	Spring Rate (lbs/in)	Spring Color
OSM-121	45	45	Grey
OSM-122	100	100	Black
OSM-123	165	165	Pink
OSM-124	235	235	Blue

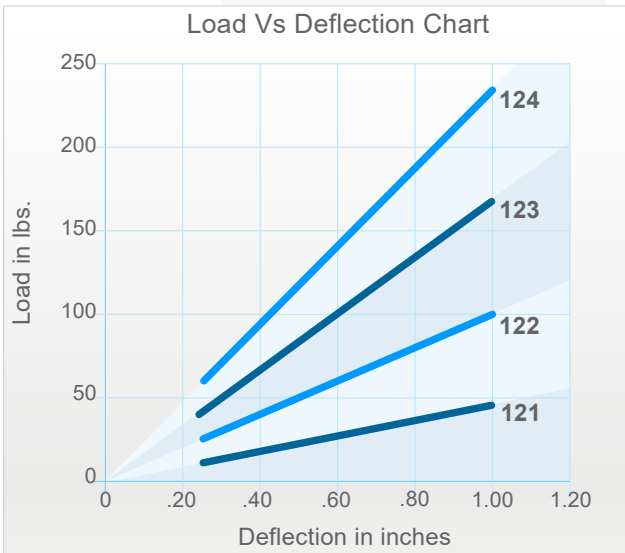

Model	Rated Load (lbs)	Spring Rate (lbs/in)	Spring Color
OSM-125	335	335	Red
OSM-126	500	500	Brown
OSM-127	850	950	Yellow
OSM-128	1,000	1,250	Green

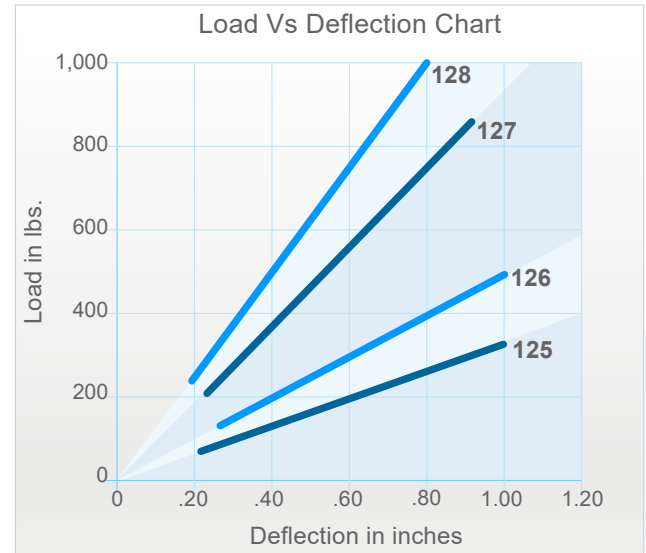

Model	Rated Load (lbs)	Spring Rate (lbs/in)	Spring Color
OSM-101	50	50	Blue
OSM-103	120	120	Brown
OSM-105	270	270	Yellow

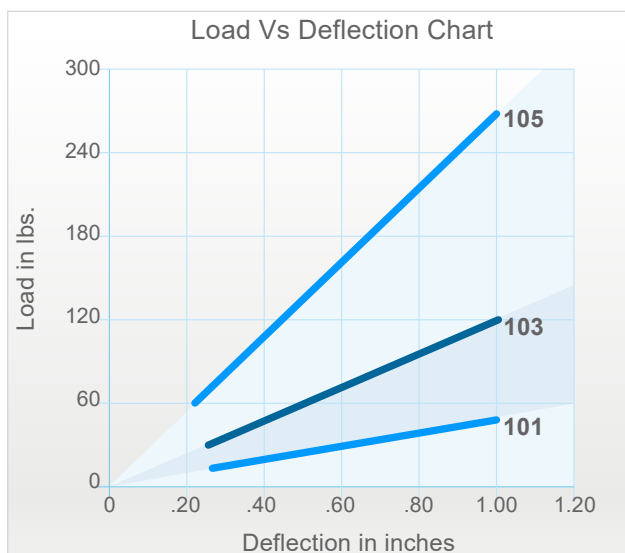

Model	Rated Load (lbs)	Spring Rate (lbs/in)	Spring Color
OSM-107	650	650	Green
OSM-109	1,000	1,190	White

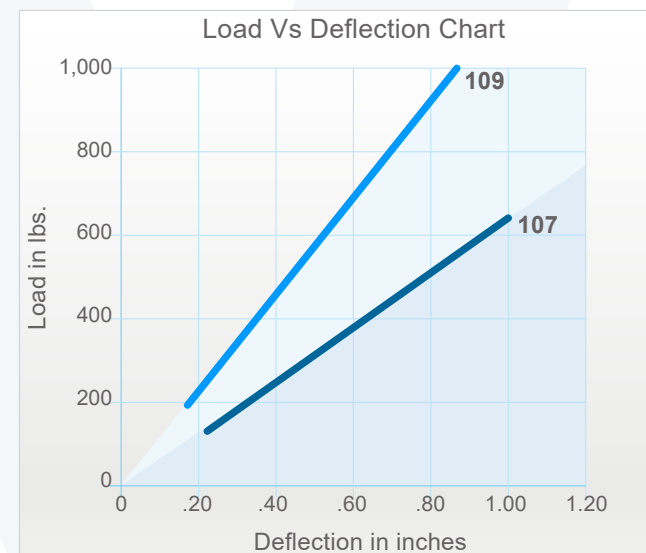

## 2" DEFLECTION OPEN SPRING MOUNTS

Model	Rated Load (lbs)	Spring Rate (lbs/in)	Spring Color
OSM-170	43	22	Blue
OSM-140	80	40	Black
OSM-172	155	78	Orange
OSM-174	236	118	White

Model	Rated Load (lbs)	Spring Rate (lbs/in)	Spring Color
OSM-175	300	150	Brown
OSM-176	395	198	Black
OSM-178	550	275	Pink
OSM-150	650	325	Grey

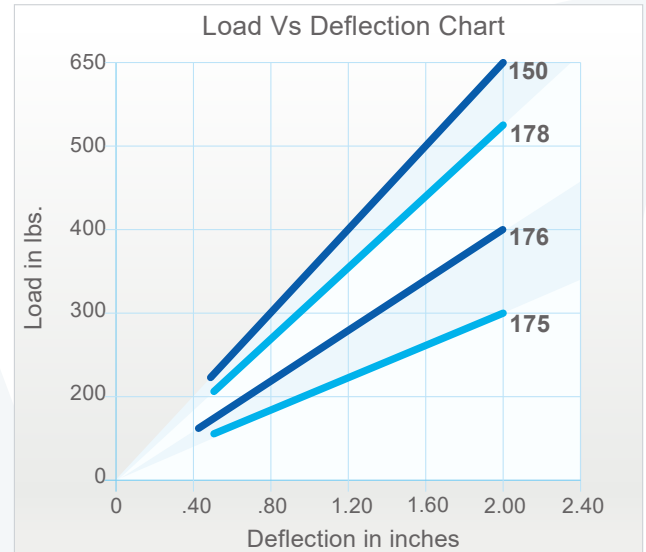
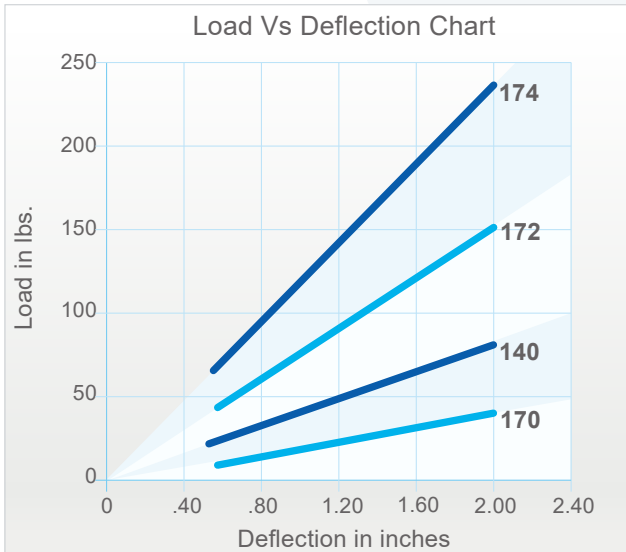

### Notes:

- a) Do not use Open Spring Mounts for external applications without independent restraints.
- b) Open Spring Mounts are not designed to accommodate angular misalignments, and must not be used for tensile or shear loadings.
- c) Rated load is the maximum load recommended.
- d) 120 Springs: 2" Outside diameter x 3" Free Length. (\*)
- e) 100 Springs: 2" Outside diameter x 4" Free Length.
- f) 140 & 170 Springs: 2" Outside diameter x 5" Free Length.
- g) 150 Springs: 2" Outside diameter x 5.75" Free Length.