

## 2" & 3" DEFLECTION SPRING ELASTOMER HANGERS

**HD-S-E** models are heavy duty hangers and incorporate a new design of steel housing, with the base's two sides bent down. This considerably increases the rigidity of the steel frame, eliminating the possibility of the bending of the frame's bottom plate under heavy loads. These hangers have three elastomer parts. The top and bottom spring's rubber cups have vulcanized steel washers for even load distribution. The bottom cup has a locator rubber ring to center the cup and spring in the hanger's housing. The third part is an elastomer element with the rubber ring to center the element in the top opening of the housing's frame. Depending on the load, different sizes and hardness of the elements are recommended and available. These elastomer cups reduce the transfer of vibration and noise.



### Recommended for:

Spring hangers are used for fan coil units, air circulation units, pipes, ducts, and other suspended structures and building services.

### Features:

- ✓ All springs at rated load have 50% additional travel to solid load.
- ✓ Housing is yellow zinc plated for better corrosion resistance.
- ✓ Safety factor - Springs will accommodate 50% extra load from rated load to solid load.
- ✓ All hangers' elements are safe at solid load.
- ✓ Springs are color-coded and easily replaceable.
- ✓ Top and bottom elastomer cups and elements have embedded steel washer for uniform load distribution.
- ✓ New base plate design of the steel housing with two bent sides considerably increases rigidity of the frame

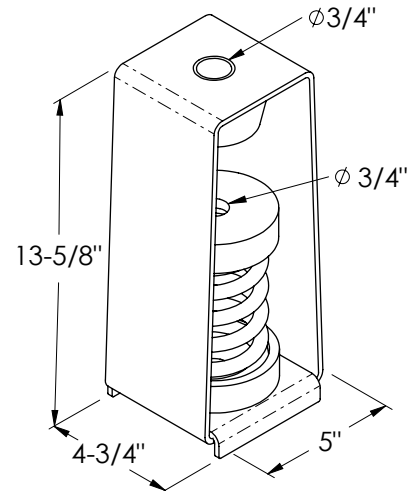

### Installation Instructions:

In order to allow isolators to operate efficiently install hangers with a gap as shown below. Hangers are designed to compensate for minor misalignments.

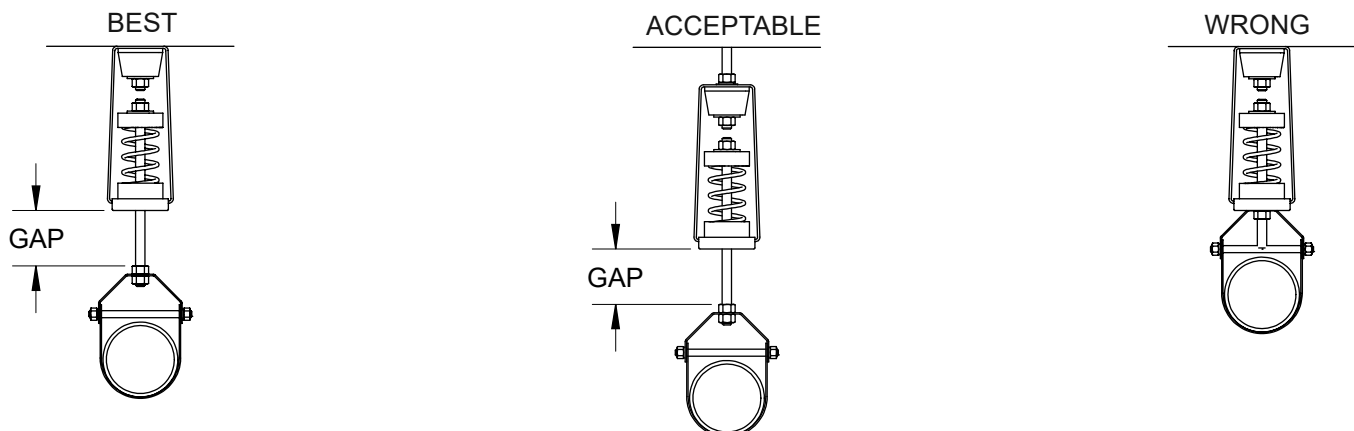

## 2" DEFLECTION SPRING ELASTOMER HANGERS

Model	Rated Load (lbs)	Deflection at Rated Load (lin)	Spring Rate (lbs/in)	Spring Color
HD-S-350-E3-40	80	2	40	Red
HD-S-352-E3-40	125	1.8	70	Yellow
HD-S-350-140-E3-40	160	2	80	Red/Black
HD-S-403-E3-40	348	2	174	Black
HD-S-404-E3-40	453	2	226	Blue
HD-S-405-E3-60	590	2	295	Red
HD-S-406-E3-60	676	2	338	Orange
HD-S-407-E3-60	787	2	393	Green
HD-S-408-E3-60	918	2	459	White
HD-S-409-E3-80	1,000	2	500	Brown
HD-S-410-E3-80	1,250	2	625	White
HD-S-407-150-E3-80	1,587	2	793	Green/Grey
HD-S-409-150-E3-80	1,800	2	900	Brown/Grey
HD-S-410-150-E3-80	2,050	2	1,025	White/Grey

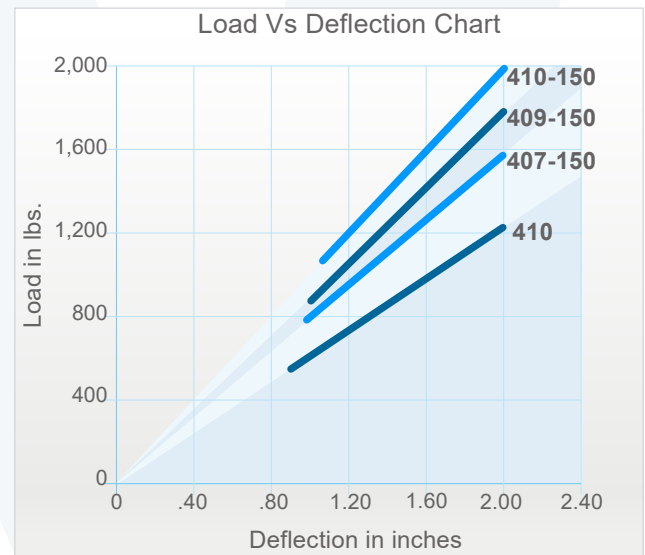
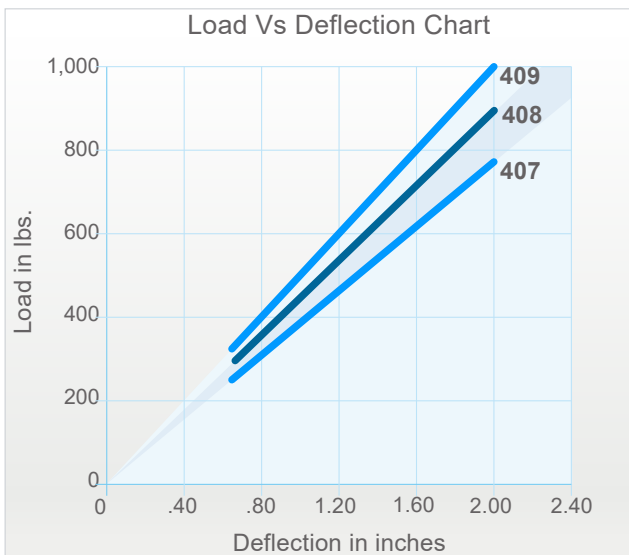
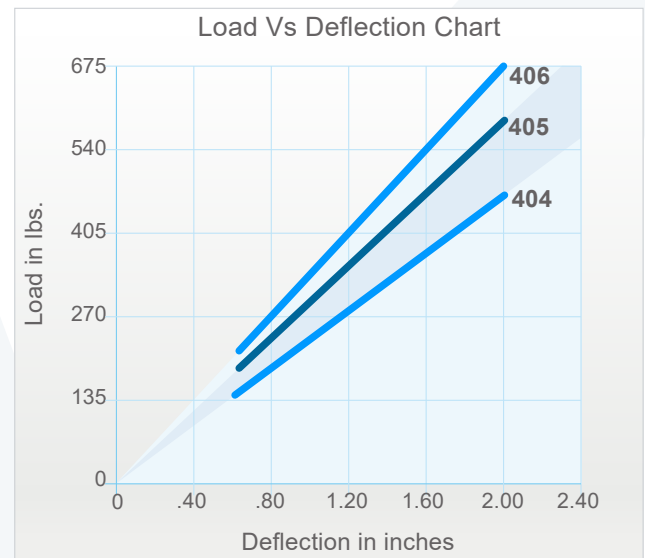
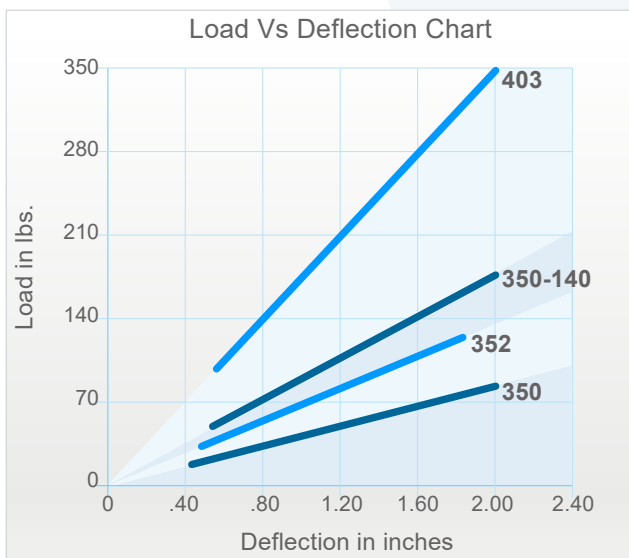

## 3" DEFLECTION SPRING ELASTOMER HANGERS

Model	Rated Load (lbs)	Deflection at Rated Load (lin)	Spring Rate (lbs/in)	Spring Color
HD-S-601-E3-40	140	3	47	Blue
HD-S-602-E3-40	200	3	67	Yellow
HD-S-603-E3-40	300	3	100	Orange
HD-S-604-E3-40	450	3	150	Red

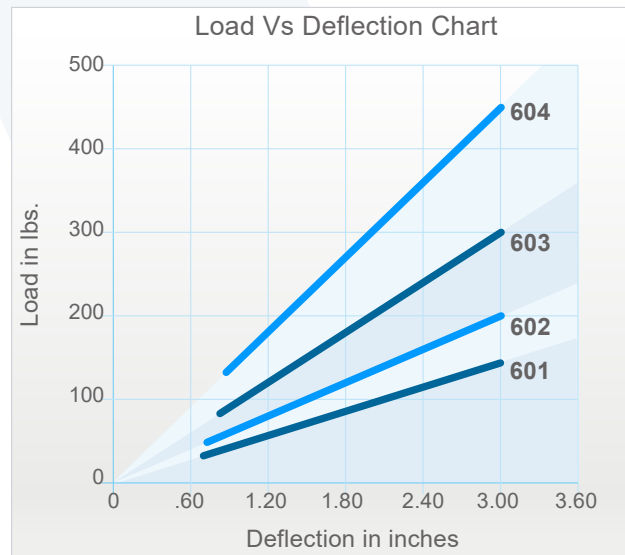

### Notes:

- 350 Spring: 3" Outside diameter x 5" Free Length.
- 140 Spring: 2" Outside diameter x 5" Free Length.
- 400 Spring: 3" Outside diameter x 5.75" Free Length.
- 150 Spring: 2" Outside diameter x 5.75" Free Length.
- 600 Spring: 3" Outside diameter x 6.75" Free Length
- Rated load is the maximum load recommended.